



Manumed Optimal 3-section

The most versatile
treatment and
examination couch



Manumed Optimal 3-section

The versatility of the Manumed Optimal 3-section offers you, the modern and demanding physiotherapist, the perfect treatment and examination couch. Everything is possible: lying and sitting positions, Trendelenburg and flexion position, which can be adjusted during treatment with the patient simply remaining on the couch. In short, the most universal couch available, which gives both the therapist and the patient the experience of comfortable treatment. Elegant in appearance and sturdy on its retractable castors, the Manumed Optimal 3-section is the obvious choice for the therapist who makes high demands on a professional top quality treatment couch.



"A fantastic all-round examination and treatment couch"



Manumed Optimal 3-section

- 3 (to 5) adjustable sections
- Many adjustable positions, including the flexion- and (anti-) Trendelenburg positions
- Electrically adjustable pli comes standard with electrical high/low variant
- Load capacity up to 200 kg (some models optional to 250 kg)
- Head section folds down completely for better access of the cervical region
- Optimally positioned handles
- Long nose hole, allowing proximal or distal movement of the patient even when lying in prone position
- Optional a triangular nose hole or without nose hole
- Wheel raising mechanism for easy movement of the couch
- Height can be adjusted hydraulically (no mains lead needed) or electrically (very convenient, smooth and quick)
- Completely relaxed starting position in the face-down position with separate head section (optional)

Manumed Optimal 3-section without flexion position

Type

212 3-section without flexion-position, hydraulic H/L

222 3-section without flexion-position, electric H/L

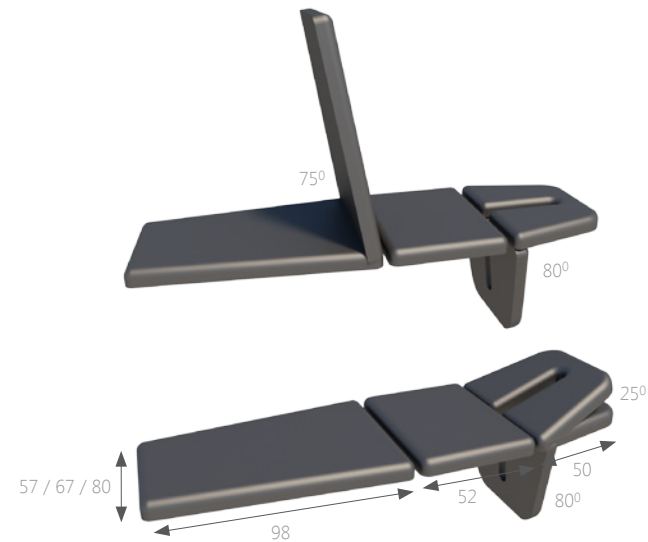

ORDERING DATA

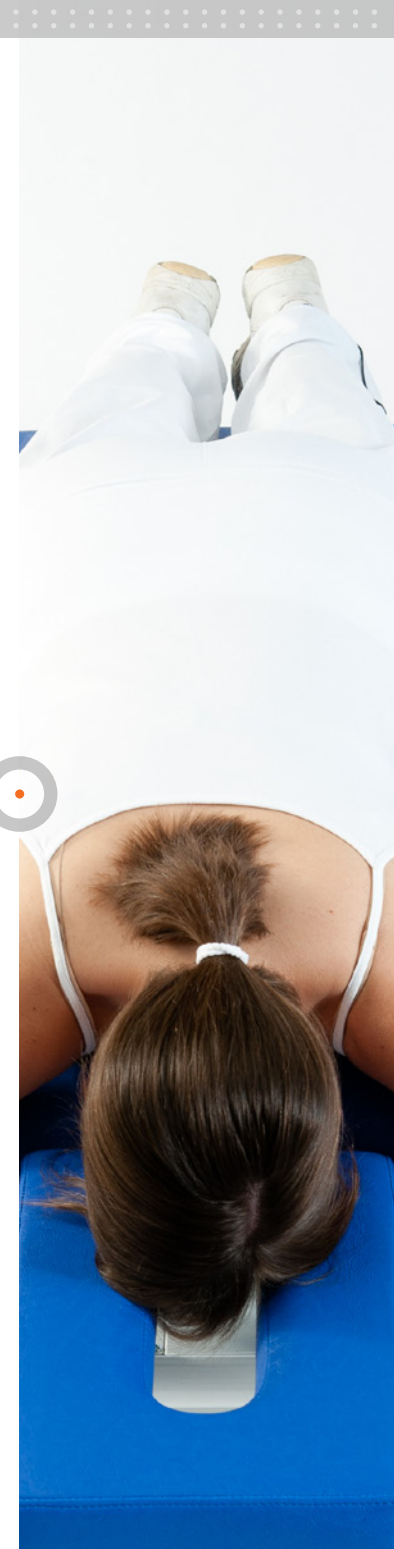

Manumed Optimal 3-section with flexion position

Type

213 3-section, gasspring supported flexion-position, hydraulic H/L

243 3-section, electric flexion-position and electric H/L

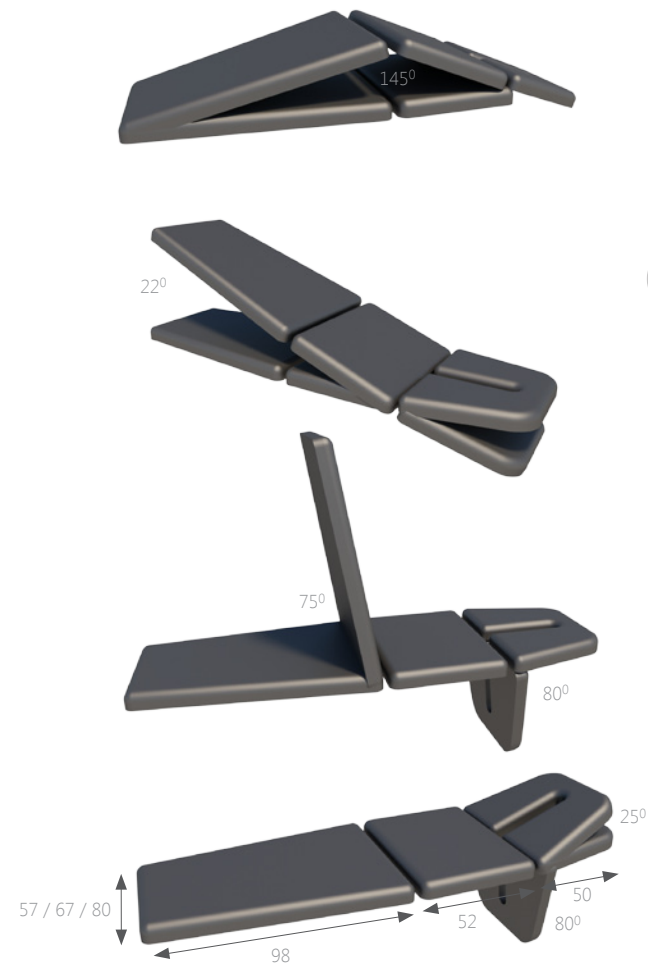

Manumed Optimal 3-section with flexion position and with adjustable arm sections

ORDERING DATA

Type

- 214 3-section, head-section with adjustable arm sections, without flexion position, hydraulic H/L
- 224 3-section, head-section with adjustable arm sections, without flexion-position, electric H/L
- 215 3-section, head-section with adjustable arm sections, gasspring supported flexion position, hydraulic H/L
- 245 3-section, head-section with adjustable arm sections, with electric flexion position, electric H/L

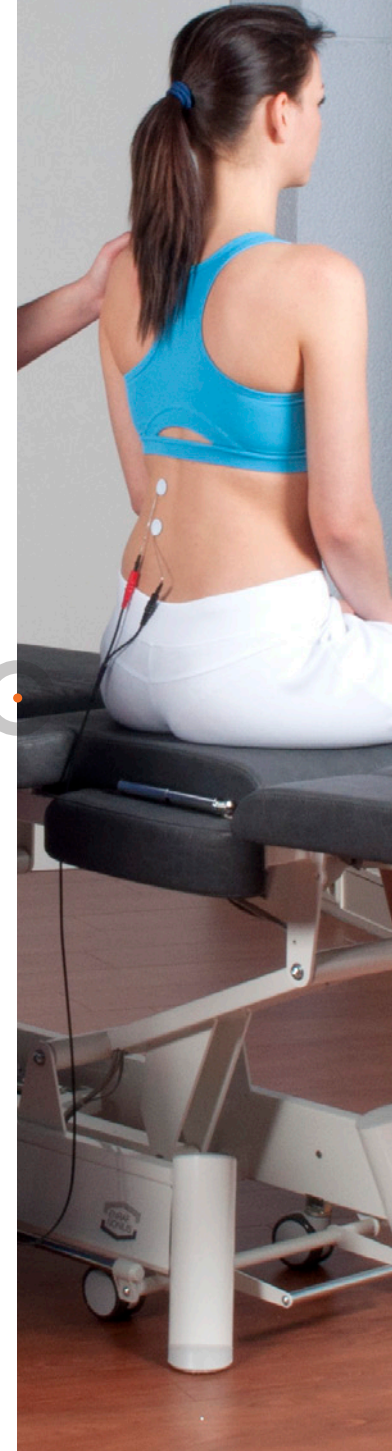
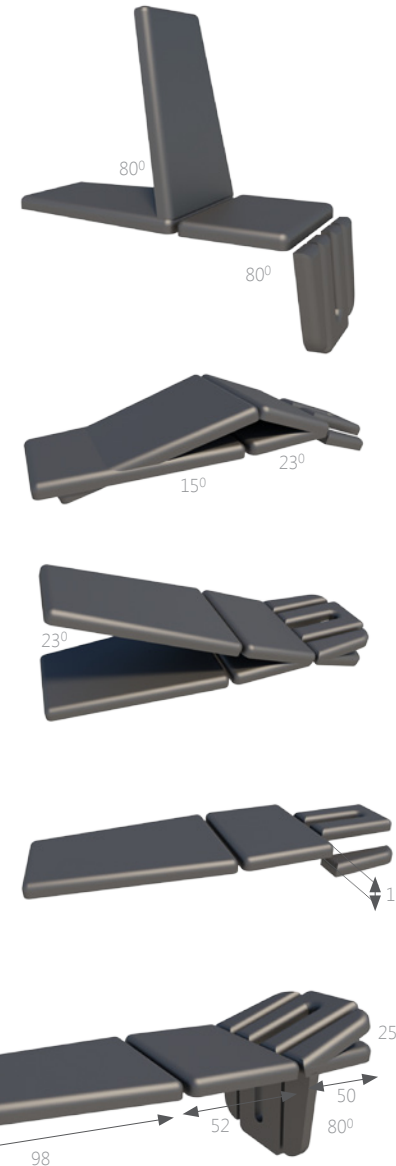

Manumed Optimal 3-section

TECHNICAL SPECIFICATIONS

Size tabletop (lxw):	204 x 67 cm (optional 57 or 80 cm width)
Height adjustment:	47-100 cm electric 47-97 cm hydraulic
Lifting time (min.-max.):	approximately 18 sec.
Lifting capacity:	200 kg (electrical motor optional 250 kg)
Power supply:	120/230VAC 50/60 Hz
Current consumption:	2.0 A max.

NOTE: ALL-AROUND OPERATION IS AN OPTION.

This is a medical device



It complies with all applicable medical regulations. For more details please consult the instructions for use (downloadable via www.enraf-nonus.com).

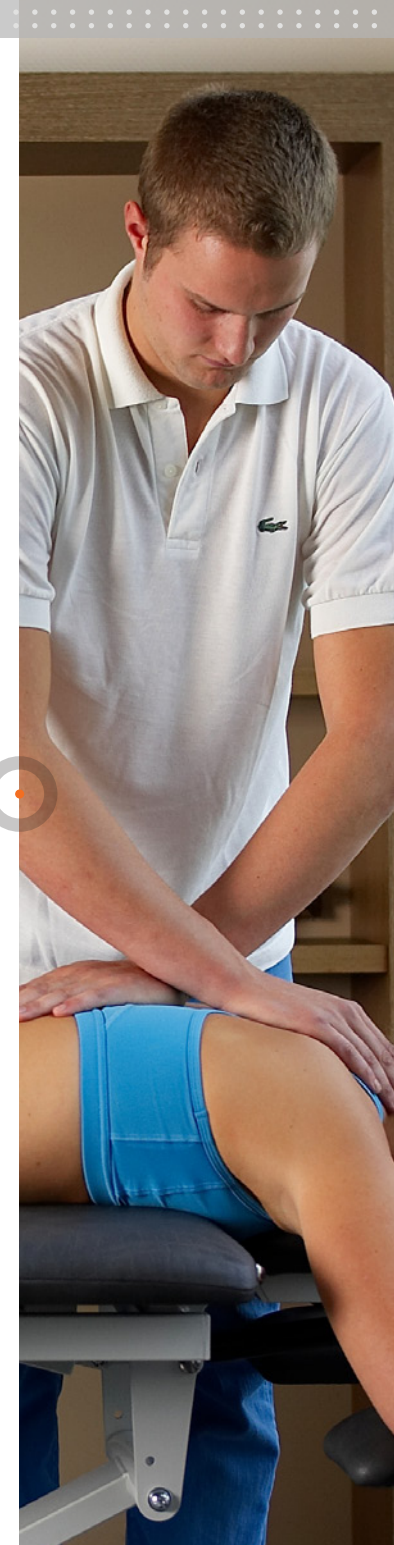

Manumed Colours

OPTIONS⁽¹⁾

A matching Enraf-Nonius couch for every interior. As in other practices, a pleasant ambience is important in physiotherapy practices. Clients must feel comfortable in the room where they are being treated. As each practice is furnished differently and has its own colour scheme, we regard it as important for the treatment couches to fit in with your look and feel. That is why we can manufacture our treatment couches in several frame and upholstery colours. Our imitation leather upholstery contains no phthalates and is flame retardant – a unique combination that makes this material suitable for medical use!

NATURAL

- 811 volcano black
- 850 walnut
- 851 sand
- 886 leaf
- 888 snow

LIFESTYLE

- 410 anthracit
- 406 petrol
- 407 cherry
- 408 terracotta
- 409 skin

EXECUTIVE

- 012 black
- 213 grey
- 199 lavender
- 204 sirius blue
- 169 cornflower blue
- 170 baby blue

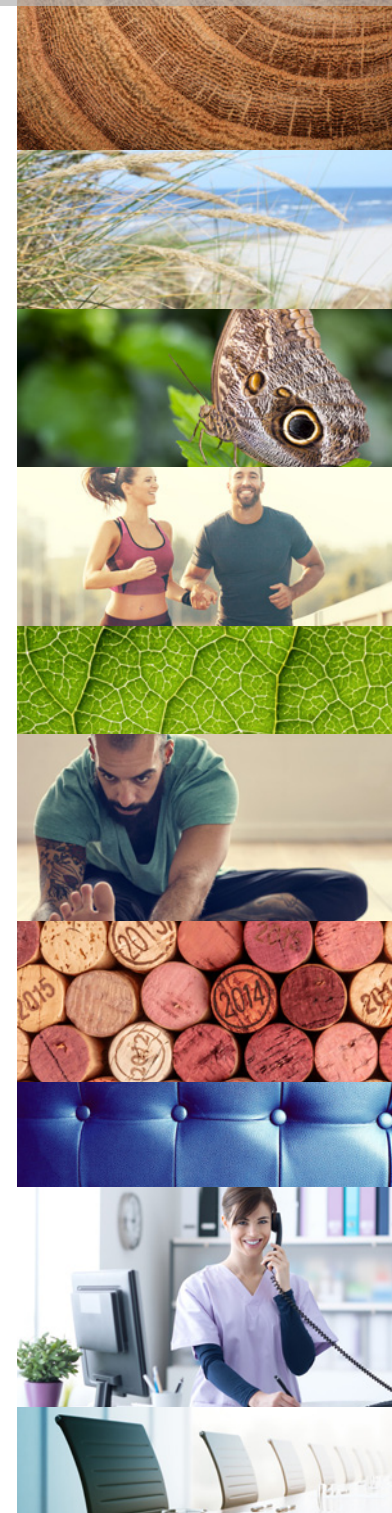

(1) = NOTE: Please order options together with the couch because of modification of the couch during production.

Manumed Colours

NATURAL



811 volcano black



850 walnut



851 sand



886 leaf

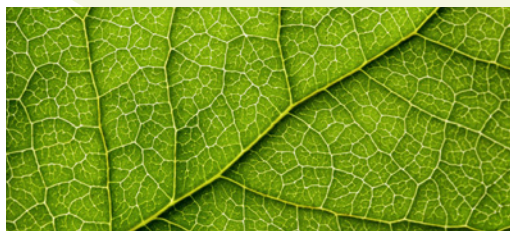

888 snow

Manumed Colours

LIFESTYLE

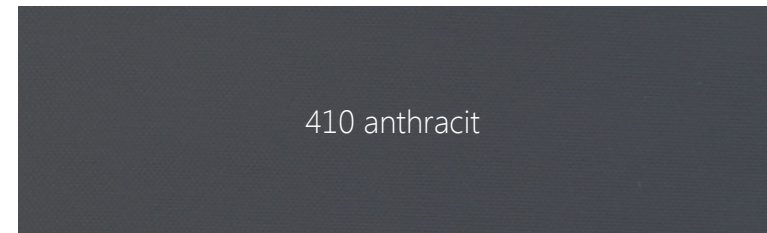
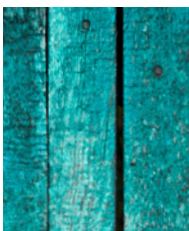

410 anthracit

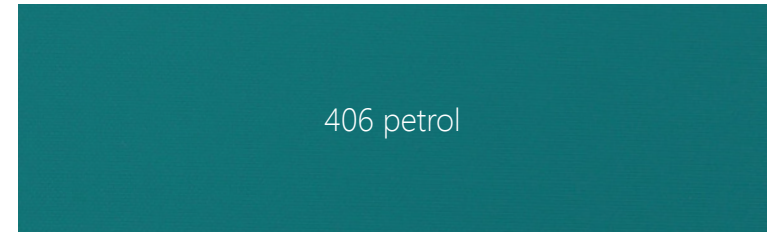

406 petrol

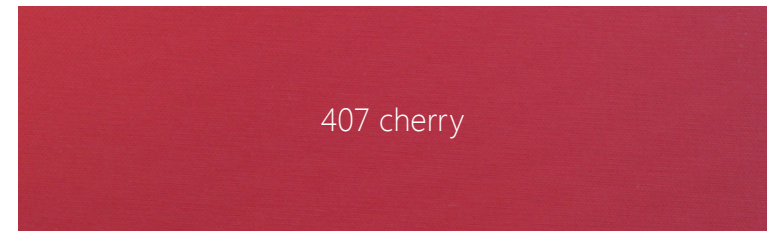

407 cherry



408 terracotta

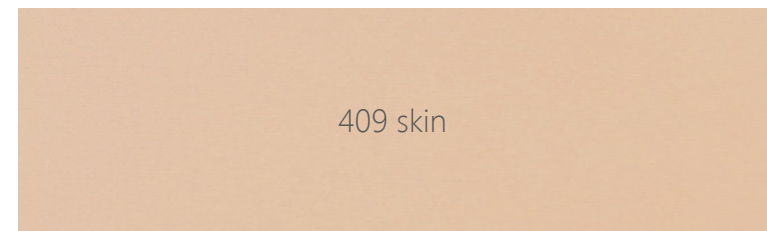

409 skin

Manumed Colours

EXECUTIVE

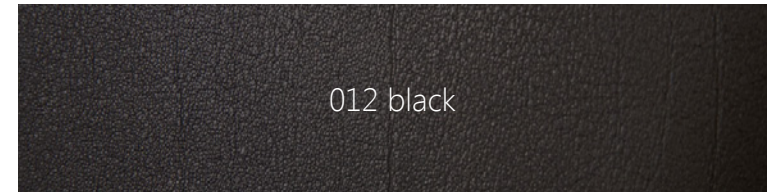

012 black



213 grey



199 lavender

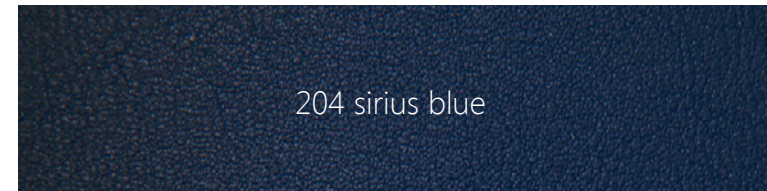

204 sirius blue

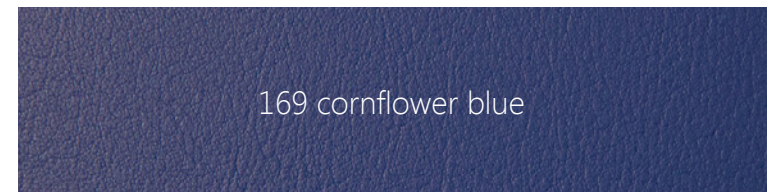

169 cornflower blue

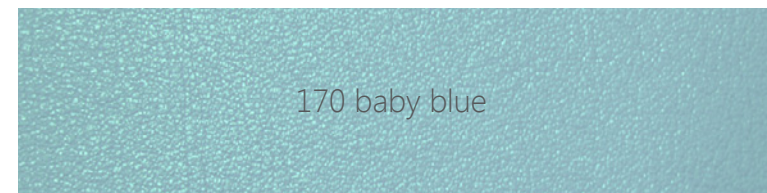

170 baby blue

Frame colours

Ral 7035 grey

Ral 9005 black

Ral 9010 white

OPTIONS⁽¹⁾



(1) = NOTE: Please order options together with the couch because of modification of the couch during production.

Manumed Optimal 3-section

OPTIONS⁽¹⁾

Upholstery options

Section Width	57 cm	67 cm	80 cm
Standard 4 cm thick	s	s	s
DeLuxe 6 cm thick	o	o	o
Extra hard 4 cm thick	o	o	o
Extra soft 5,5 cm thick	o	o	o
Trapzium shaped leg section	x	s	s
Rectangular shaped leg section	s	o	x

s = standard o = optional x = not available

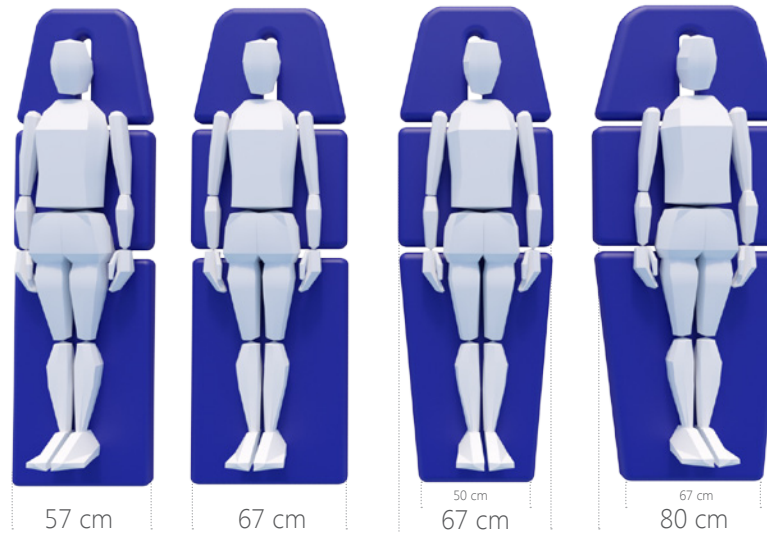

Foam density:

Standard:	38 Kg/m ³
DeLuxe:	38 Kg/m ³
Extra hard:	70 Kg/m ³
Extra soft:	4 cm 38 Kg/m ³ + 1,5 cm 30 Kg/m ³

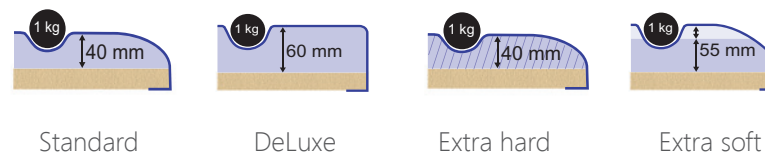

(1) = NOTE: Please order options together with the couch because of modification of the couch during production



Manumed Optimal 3-section

OPTIONS⁽¹⁾

Nose-hole

- A. Oblong nose-hole including plug (standard)
- B. Triangular shaped nose-hole (optional) excluding plug, please order separately 1550813
- C. No nose-hole (optional)

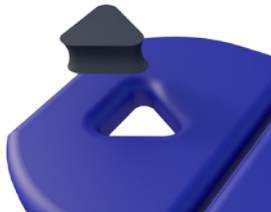

1550813

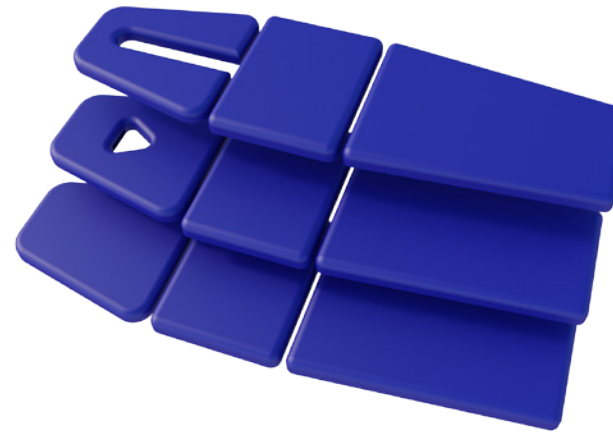

Height adjustment

- A. Hydraulic types 212 / 213 / 214 / 215
- B. Electric (222 / 243 / 224 / 245) Footswitch (standard)
- C. Electric (222 / 243 / 224 / 245) All-around (optional)



A



B



C

(1) = NOTE: Please order options together with the couch because of modification of the couch during production

Manumed Optimal 3-section

OPTIONS⁽¹⁾

Lifting capacity

- A. Electric - max. 200 kg (standard)
- B. Electric - max 250 kg (optional)
- C. Hydraulic max 200 kg



A



B



C

Optional features

- A. Ergo-wings (only for 67 cm width)
- B. Safety switch

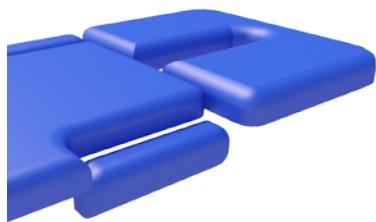

A



B

(1) = NOTE: Please order options together with the couch because of modification of the couch during production

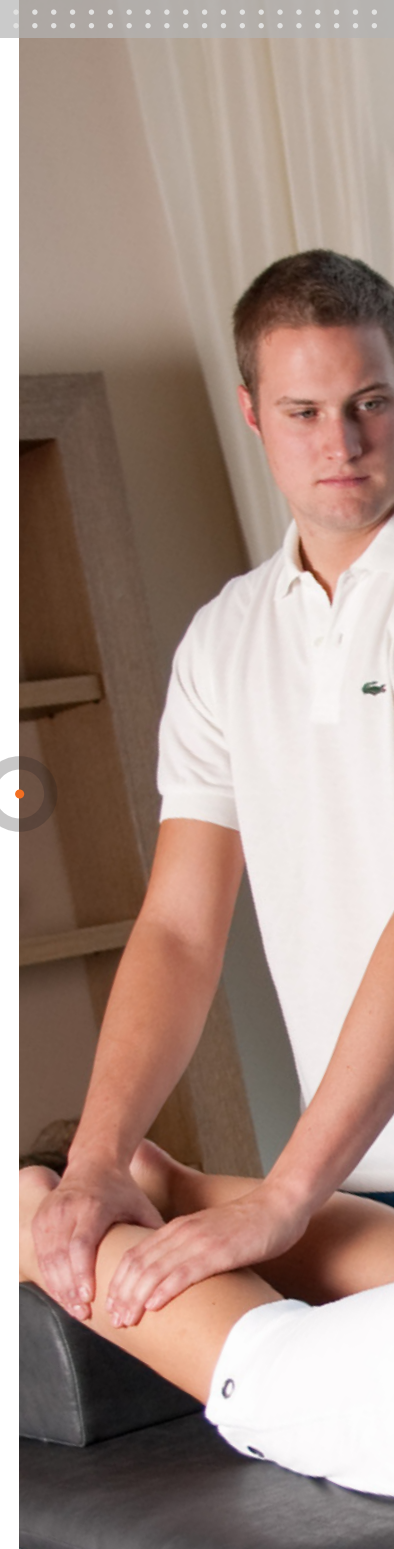

Manumed Optimal 3-section

ACCESSORIES

Paper roll holder and paper rolls

- 3450104 Paper roll holder for Manumed Optimal, for 50 & 60 cm rolls, mounted onder foot-section
- 3450105 Paper roll holder for Manumed Optimal, for 50 & 60 cm rolls, mounted under headsection
- 3445280 Paper roll stand (floor type) for 50 & 60 cm rolls
- 3445278 Paper roll, width 50 cm, roll-length 150 m, per 5 rolls
- 3445279 Paper roll, width 60 cm, roll-length 150 m, per 5 rolls



3450104



3450105



3445280

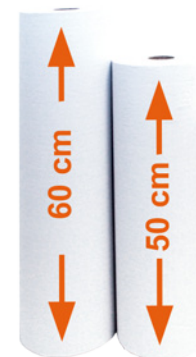

3445278 / 3445279



Manumed Optimal 3-section

ACCESSORIES

Fixation accessories

- 3xxx035 Shoulder/neck support, set of 2 (available in different colours, see page Manumed Colours)
- 3450036 Clamp for fixation horn 3xxx035 (2 pieces)
- 3xxx031 Pelvic support incl. mounting bracket (available in different colours, see page Manumed Colours)
- 3496187 Fixation rail for fixation horn armpit or gynaecological set: (1550810 / 1550805 / 3xxx028)*
- 3XXX028 Armpit fixation horn (available in different colours, see page Manumed Colours)



3xxx035

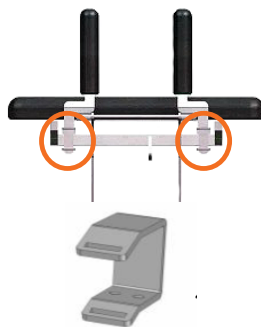

3450036



3xxx031



3496187



3XXX028



* Only for couches 213, 215, 243 und 245

Manumed Optimal 3-section

ACCESSORIES

Fixation straps

- 3445023 Fixation strap with velcro fastener 120 cm
- 3445014 Fixation strap with velcro fastener 160 cm
- 3445015 Fixation strap with velcro fastener 240 cm
- 3445475 Fixation strap with safety lock 250 cm
- 3445474 Fixation strap with safety lock 350 cm



3445023



3445014 / 3445015



3445474 / 3445475



Stools

ACCESSORIES

- 3xxx010 Stool, height adjustable 40-53 cm
- 3xxx011 Stool, mobile, height adjustable 59-85 cm
- 3xxx012 Stool, mobile, provided with footrest, height adjustable 59-85 cm
- 3xxx013 Stool, mobile, anatomic seat, height adjustable 43-56 cm
- 3xxx020 Stool, mobile, saddle seat, height adjustable 59-85 cm



3xxx010



3xxx011



3xxx012







3xxx013

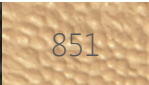
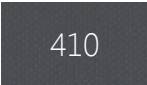
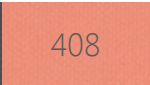
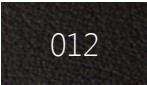
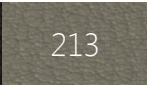

3xxx020

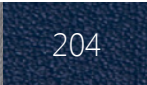
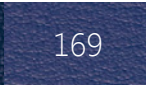
Available in all colours shown below

NATURAL	LIFESTYLE	EXECUTIVE
 811  851	 410  408	 012  213  199  204  169  170

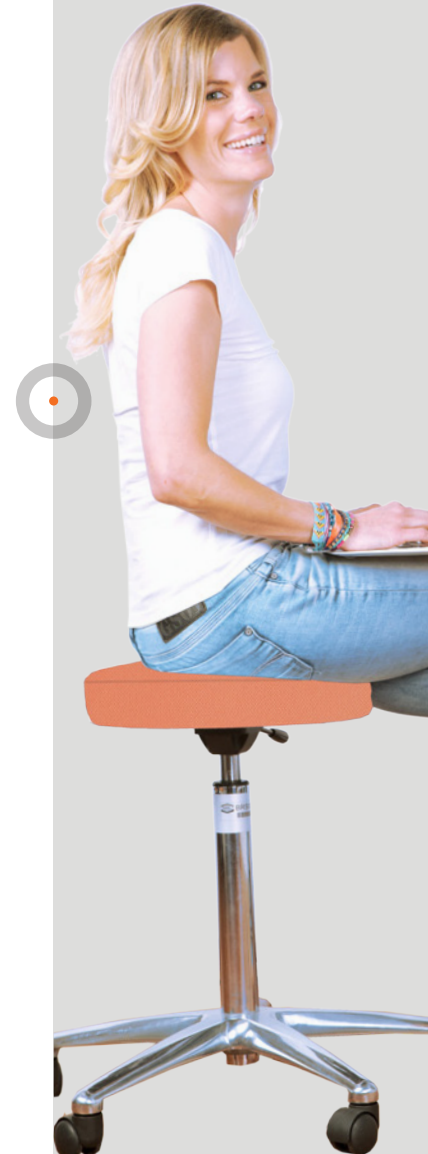

Rolls and cushions

3xxx002	Halfroll, flat bottom, small, especially for the ankle	28x9x11 cm
3xxx003	Halfroll, flat bottom, large	56x16x18 cm
3xxx023	Massage roll	50x Ø15 cm
3xxx004	Neck cushion, hourglass type	30x15 cm
3xxx005	Massage cushion	30x28x8 cm
3xxx015	Wedge shaped cushion	50x30x15 cm

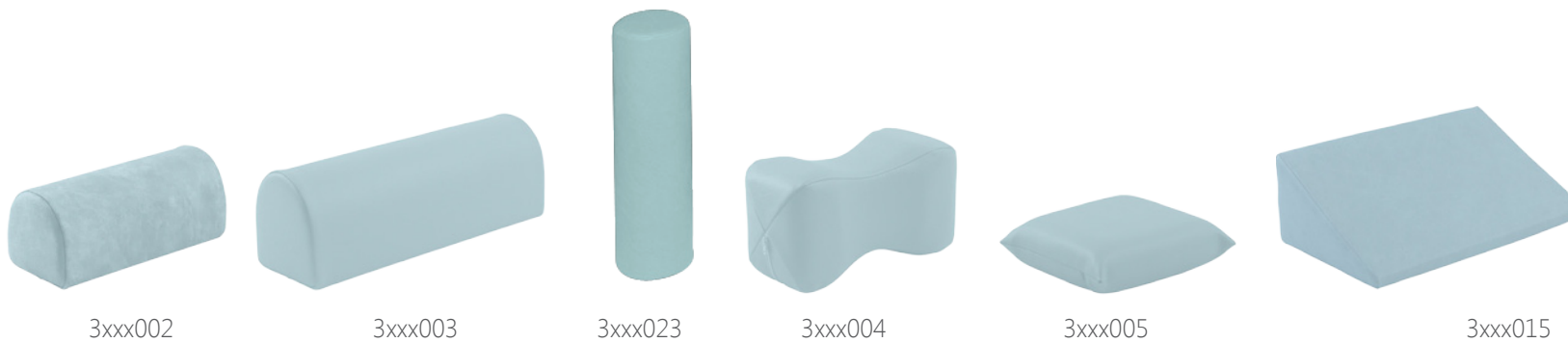

Available in all colours shown below

NATURAL	LIFESTYLE	EXECUTIVE
811 851	410 408	012 213 199 204 169 170

ACCESSORIES



Rolls and cushions

1550813 Plug for nosehole, triangular shaped ⁽¹⁾

16,5 x 21 cm

3445297 Wedge shaped, Kaltenborn, rubber model ⁽¹⁾

22,5 x 10,5 x 8,5 cm

3446161 Support bag with sand 1,2 kg ⁽²⁾

15x25 cm

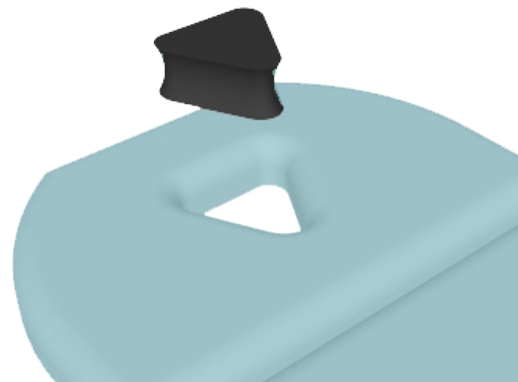

1550813



3445297



3446161

(1) = only available in black

(2) = only available in grey

ACCESSORIES

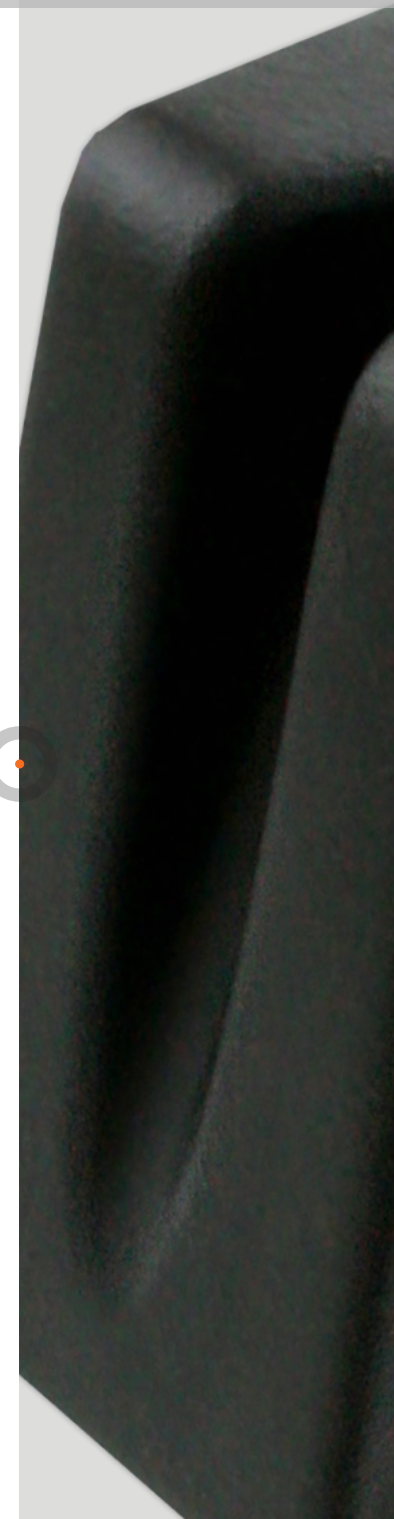

Couch covers

3445240	Couch cover, with a cutaway for the nose	blue
3445241	Couch cover, with a cutaway for the nose	bordeaux
3445242	Couch cover, with a cutaway for the nose	white
3445244	Couch cover, with a cutaway for the nose	jade
3445249	Couch cover, with a cutaway for the nose	dark grey
3445250	Couch cover, with a cutaway for the nose	royal blue
3445261	Couch cover, without a cutaway for the nose	blue
3445034	Couch cover, without a cutaway for the nose	bordeaux
3445267	Couch cover, without a cutaway for the nose	white
3445262	Couch cover, without a cutaway for the nose	jade
3445248	Couch cover, without a cutaway for the nose	dark grey
3445247	Couch cover, without a cutaway for the nose	royal blue
3445259	Elastic straps for couch cover with clip fittings at both ends, set of 3	

ACCESSORIES



3445240
3445261



3445241
3445034



3445242
3445267

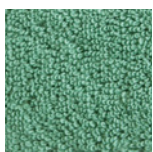

3445244
3445262

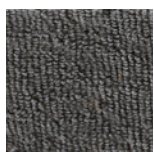

3445248
3445249

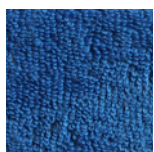

3445247
3445250



3445259

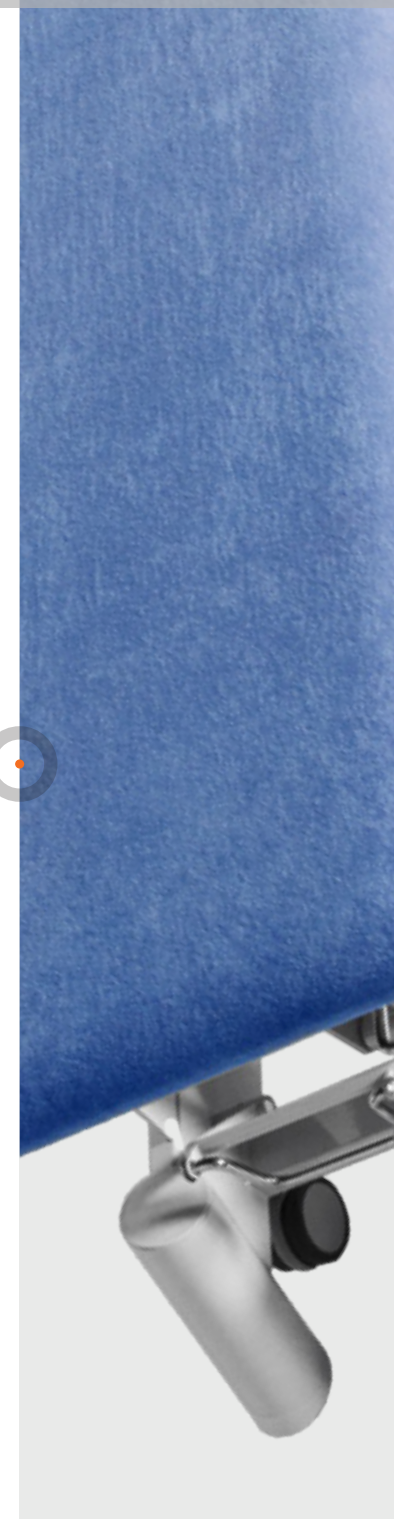

Manumed Optimal 3-section

ACCESSORIES

Gynaecology accessories*

3496187 Fixation rail for fixation horn armpit or gynaecological set: (1550810 / 1550805 / 3xxx028)

1550810 Gynaecological Comfort set

1550805 Gynaecological set



3496187



1550810



1550805

Raising set

3450067 Raising set (30 mm)



3450067

* Only for couches 67 cm wide with flexion position

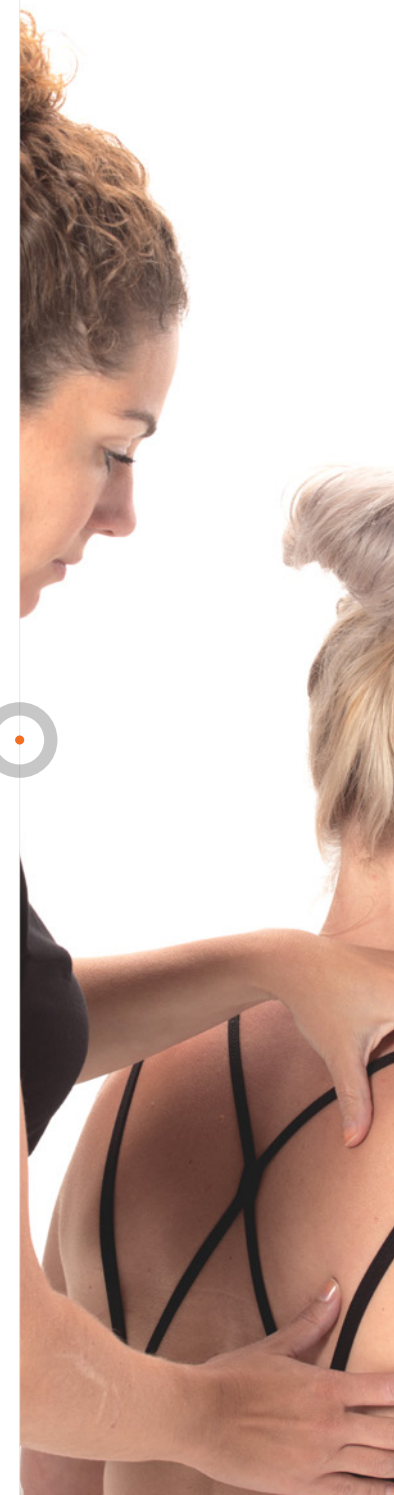



Manumed Optimal 3-section

The most versatile
treatment and
examination couch

Enraf-Nonius B.V. | Vareseweg 127 | 3047 AT Rotterdam | The Netherlands
www.enraf-nonus.com | info@enraf-nonus.nl | + 31 - (0) 10 20 30 600



PARTNER FOR LIFE